

5

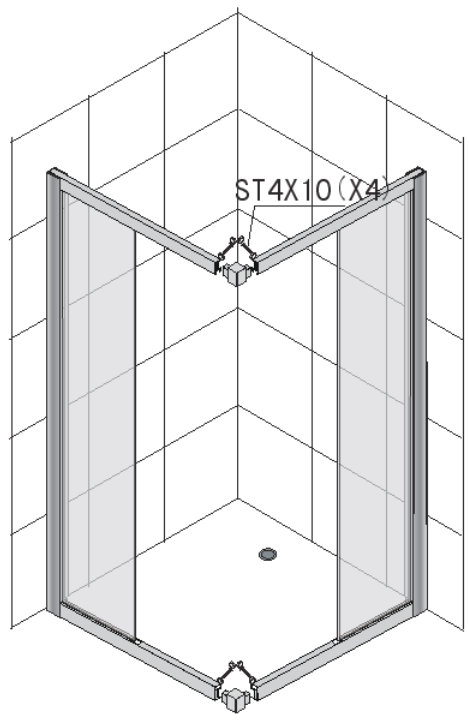

6

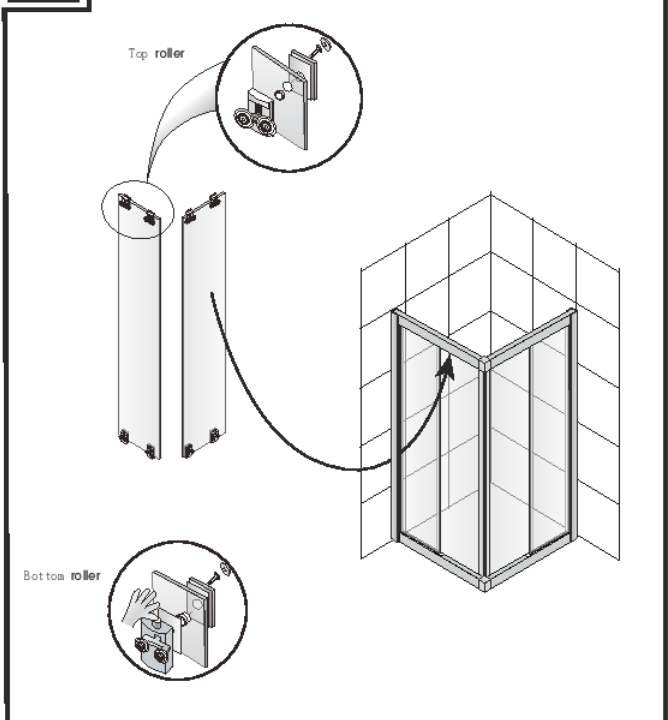

7

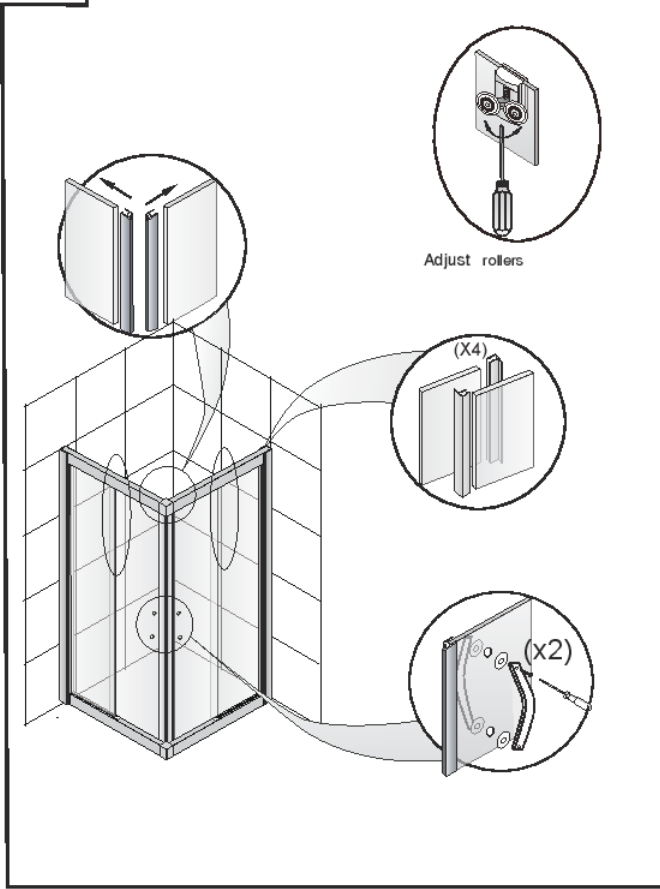

8

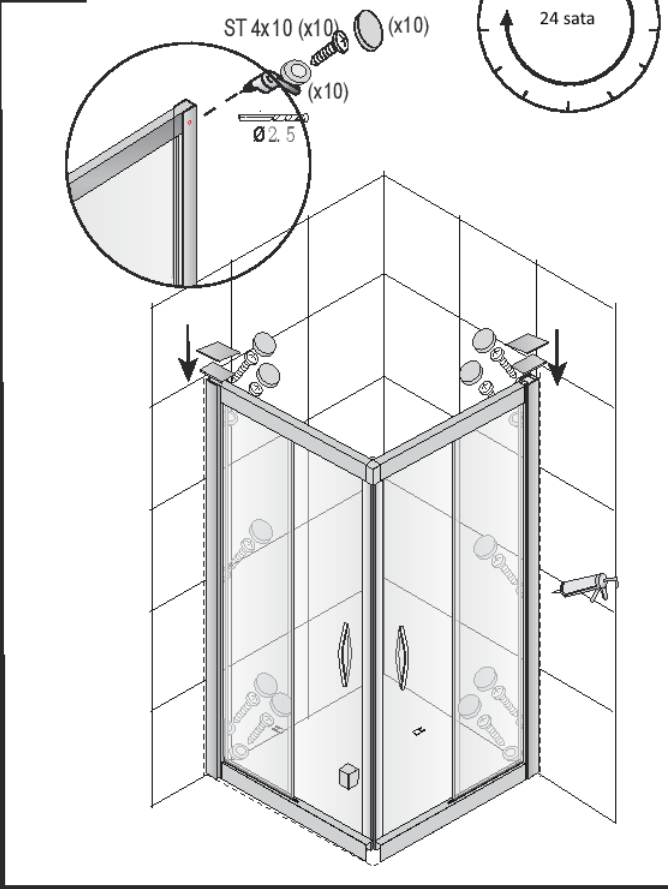

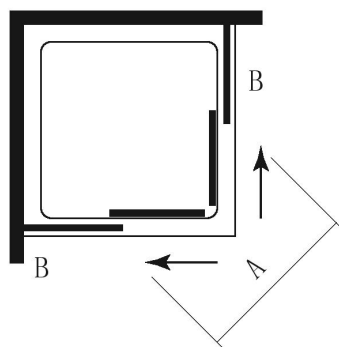
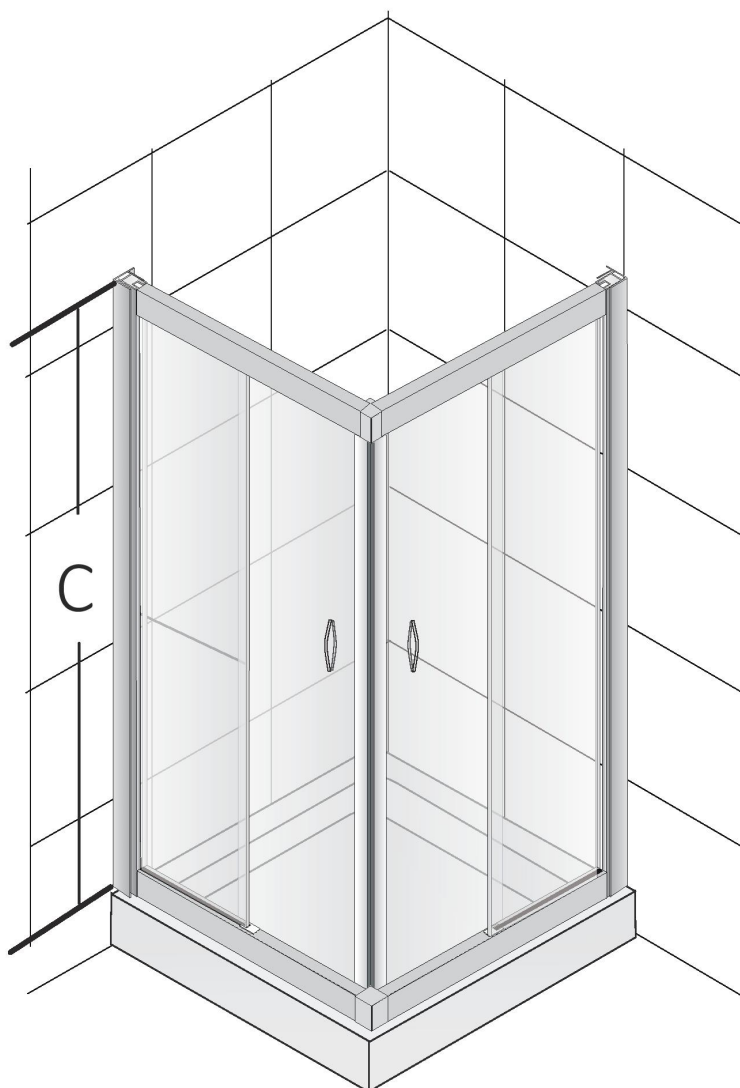

6MM  
KALJENO  
STAKLO



LAKA  
MONTAŽA  
KOTAČIĆA



PRILAGODLJIVI  
ZIDNI PROFILI



KAPICE  
PROFILA



MAGNETNO  
ZATVARANJE

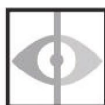

SKRIVENI  
VIJCI

Model	Size	A	B	C	Min.	Max.
SP510	800x800	432	444	1900	780	810
SP510	900x900	503	494	1900	880	910
SP510	1000x1000	574	544	1900	980	910
SP510	800x800	432	444	1600	780	810
SP510	900x900	503	494	1600	880	910
SP510	1000x1000	574	544	1600	980	910

1. Svi dijelovi tuš kabine mogu se redovno čistiti neutralnim sredstvima (npr. deterđent, sapun, voda itd).
2. Ne koristite agresivna sredstva kao što su alkohol, benzin, razrijeđivač, aceton itd.
3. Jače nečistoće možete očistiti tako što ćete pamučnom krpom utrljati pastu za zube na nečisto područje koje ćete zatim isprati vodom